

— CREATES MOBILE WORKPLACES —



# NISSAN

## Townstar, Primastar & Interstar



**SYSTEM**   
**EDSTRÖM**

# NISSAN TOWNSTAR L1

For price information, mounting time and content in our van racking packages, scan the QR code on the first page.

On electric and hybrid vans we recommend mounting by an experienced installer. Batteries and cable harnesses for approximately 400 volt must be taken in consideration. Cost of a floor may be added.



Art.No	LxDxH	Kg
F42320	1239x300x890 mm	23



Art.No	LxDxH	Kg
F42321	848x300x890 mm	17



Art.No	LxDxH	Kg
F42322	1239x300x890 mm	32



Art.No	LxDxH	Kg
F42323	804x300x890 mm	31



Art.No	LxDxH	Kg
F42324	1239x300x890 mm	43



Art.No	LxDxH	Kg
F42325	804x300x890 mm	40



Art.No	Height	Kg
F42330	190	76



Art.No	Height	Kg
F42331	250	75



Art.No	Height	Kg
F42332	360	90

# NISSAN PRIMASTAR L1H1

For price information, mounting time and content in our van racking packages, scan the QR code on the first page.

On electric and hybrid vans we recommend mounting by an experienced installer. Batteries and cable harnesses for approximately 400 volt must be taken in consideration. Cost of a floor may be added.



Art.No	LxDxH	Kg
F40840	1998x300x1000 mm	34

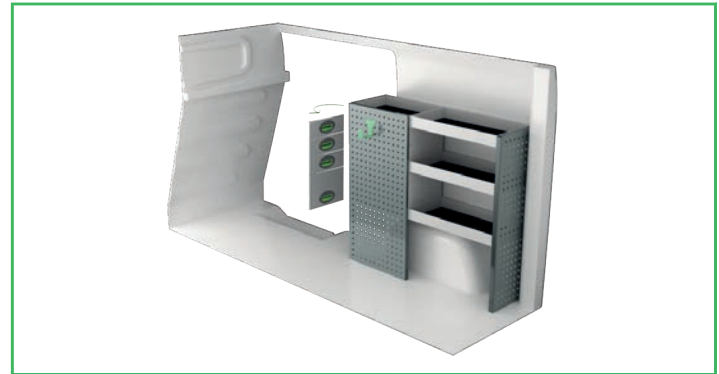

Art.No	LxDxH	Kg
F40841	1107x300x1000 mm	40



Art.No	LxDxH	Kg
F40842	1998x300x1220 mm	59



Art.No	LxDxH	Kg
F40843	1107x300x1000 mm	47



Art.No	LxDxH	Kg
F40844	1998x300x1000 mm	52



Art.No	LxDxH	Kg
F40845	1147x300x1220 mm	51



Art.No	Height	Kg
F40850	190	107



Art.No	Height	Kg
F40851	250	123



Art.No	Height	Kg
F40852	360	137

# NISSAN PRIMASTAR L2H1

For price information, mounting time and content in our van racking packages, scan the QR code on the first page.

On electric and hybrid vans we recommend mounting by an experienced installer. Batteries and cable harnesses for approximately 400 volt must be taken in consideration. Cost of a floor may be added.

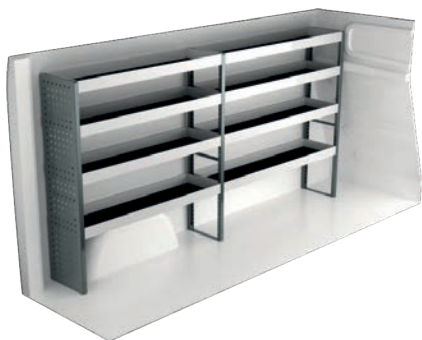

Art.No	LxDxH	Kg
F40860	2356x300x1220 mm	48



Art.No	LxDxH	Kg
F40861	1530x300x1220 mm	62



Art.No	LxDxH	Kg
F40862	2356x300x1000 mm	57

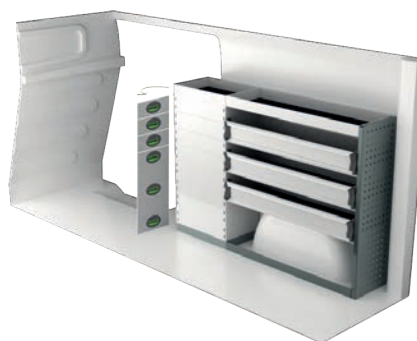

Art.No	LxDxH	Kg
F40863	1500x300x1000 mm	63

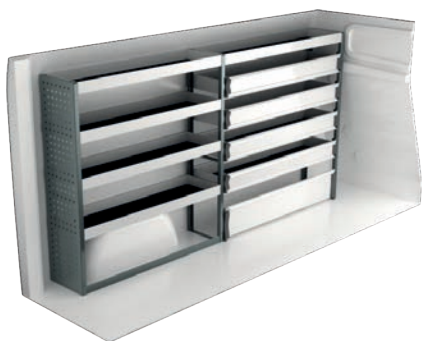

Art.No	LxDxH	Kg
F40864	2356x300x1220 mm	66



Art.No	LxDxH	Kg
F40865	1500x300x1000 mm	83



Art.No	Height	Kg
F40870	190	109



Art.No	Height	Kg
F40871	250	125



Art.No	Height	Kg
F40872	360	139

# NISSAN INTERSTAR L2H2

For price information, mounting time and content in our van racking packages, scan the QR code on the first page.

On electric and hybrid vans we recommend mounting by an experienced installer. Batteries and cable harnesses for approximately 400 volt must be taken in consideration. Cost of a floor may be added.



Art.No	LxDxH	Kg
F40500	2449x470x1220 mm	56



Art.No	LxDxH	Kg
F40501	1287x300x890 mm	44



Art.No	LxDxH	Kg
F40502	2449x470x1220 mm	86



Art.No	LxDxH	Kg
F40503	1319x300x1220 mm	69



Art.No	LxDxH	Kg
F40504	2449x300x1515 mm	93



Art.No	LxDxH	Kg
F40505	1330x470x855 mm	100



Art.No	LxDxH	Kg
F40506	2449x470x1510 mm	109



Art.No	LxDxH	Kg
F40507	1242x470x1220 mm	61

# NISSAN INTERSTAR L3H2

For price information, mounting time and content in our van racking packages, scan the QR code on the first page.

On electric and hybrid vans we recommend mounting by an experienced installer. Batteries and cable harnesses for approximately 400 volt must be taken in consideration. Cost of a floor may be added.

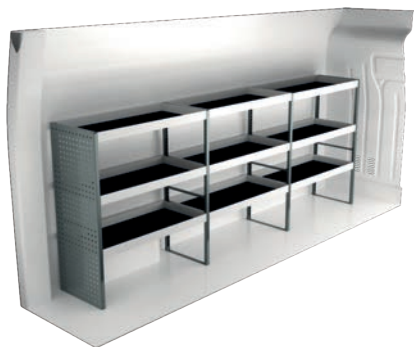

Art.No	LxDxH	Kg
F40520	3120x470x1220 mm	71

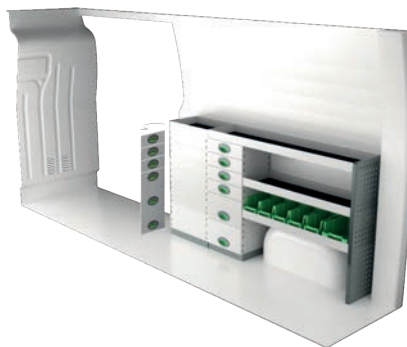

Art.No	LxDxH	Kg
F40521	1892x300x1000 mm	83



Art.No	LxDxH	Kg
F40522	3120x470x1220 mm	111

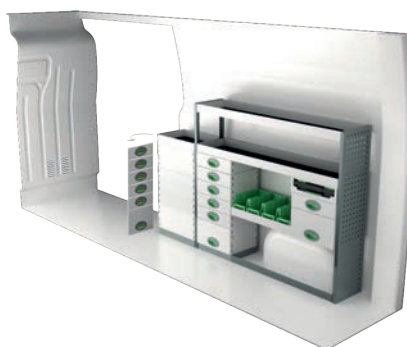

Art.No	LxDxH	Kg
F40523	1924x300x1220 mm	96

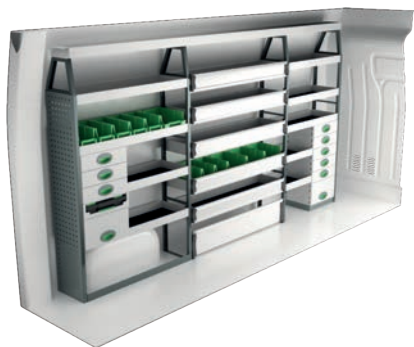

Art.No	LxDxH	Kg
F40524	3086x300x1735 mm	144

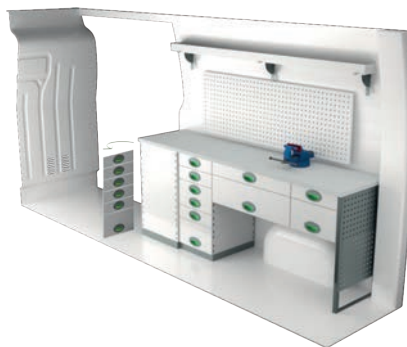

Art.No	LxDxH	Kg
F40525	2071x470x855 mm	150



Art.No	LxDxH	Kg
F40526	3054x470x1526 mm	148

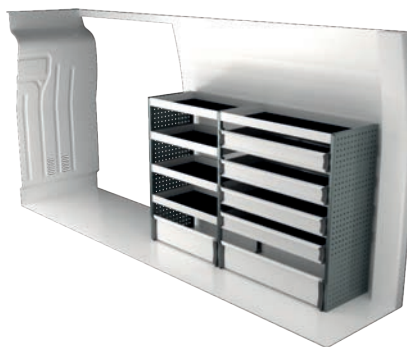

Art.No	LxDxH	Kg
F40527	1879x470x1220 mm	79

# NISSAN INTERSTAR L4H2

For price information, mounting time and content in our van racking packages, scan the QR code on the first page.

On electric and hybrid vans we recommend mounting by an experienced installer. Batteries and cable harnesses for approximately 400 volt must be taken in consideration. Cost of a floor may be added.



Art.No	LxDxH	Kg
F40560	3691x470x1220 mm	82

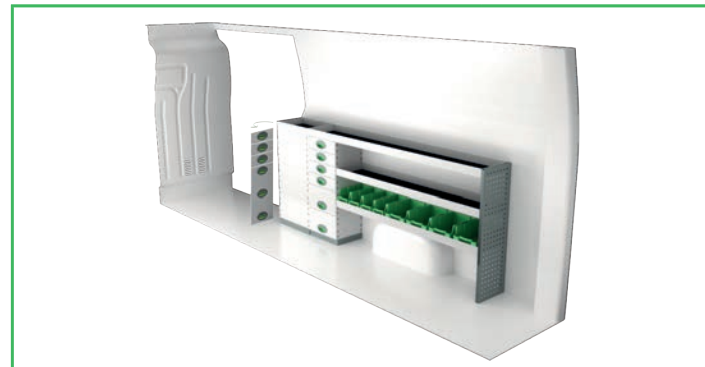

Art.No	LxDxH	Kg
F40561	2463x300x1000 mm	93

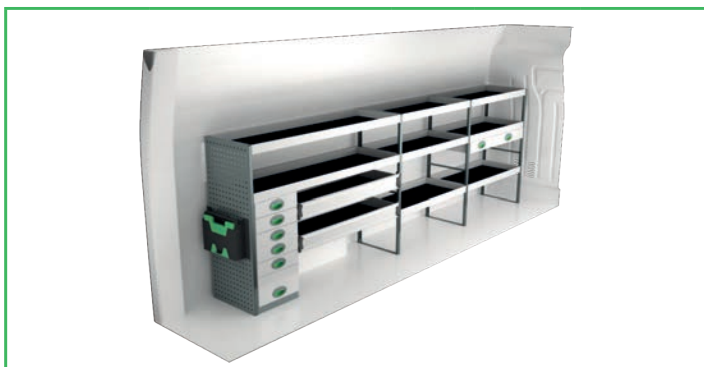

Art.No	LxDxH	Kg
F40562	3780x470x1220 mm	139



Art.No	LxDxH	Kg
F40563	2495x300x1220 mm	115



Art.No	LxDxH	Kg
F40564	3691x300x1735 mm	165

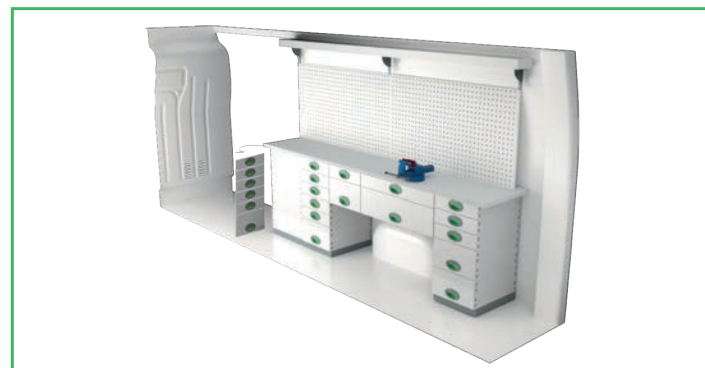

Art.No	LxDxH	Kg
F40565	2430x470x855 mm	199

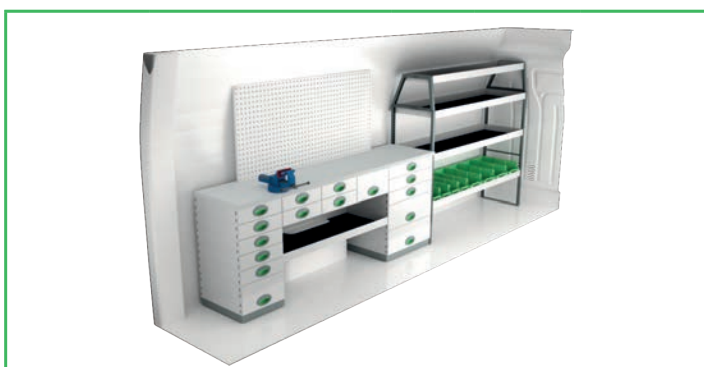

Art.No	LxDxH	Kg
F40566	3805x470x1526 mm	206

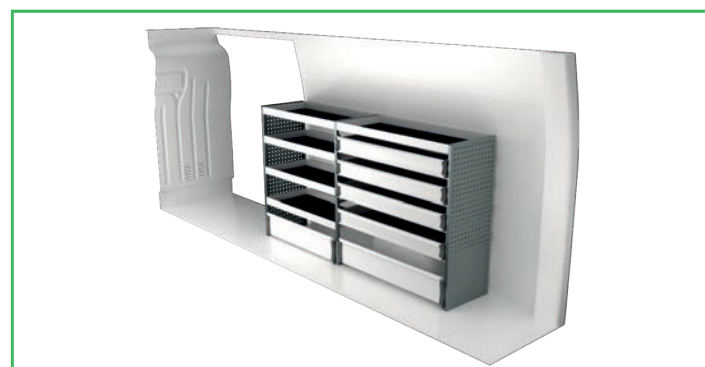

Art.No	LxDxH	Kg
F40567	2271x470x1220 mm	89

# INFORMATION



## GENERALLY

The kits include what you see in the drawing as well as installation parts, rubber mats to all shelves and foam to the drawers.

System Edström Billredningar AB is certified according to SS-EN ISO 9001:2015 to secure the administrative quality and to give us the possibility to keep a high accuracy on deliveries.

All material used in System Edström can be recycled to 100%. We are also certified according to SS-EN ISO 14001:2015.



## REMEMBER

Now that you have chosen to have System Edström in your vehicle you have taken the first and most important step to make your mobile workshop safe and functional. From here on it is up to you how safe and functional your working place will be.

You as the driver has the full responsibility if you or any one else is injured if the cargo is poorly secured. It is also your responsibility to make sure that the interior is mounted in the safest way possible whatever your choice of workshop, even if they are professionals with knowhow and long experience.

Make sure NOT to exceed the maximum payload of the vehicle.



## SECURITY

Our products are tested in two ways, the first and most important is two crashtests, one (ECE 17:07) performed by Milbrook in England and another one performed by Valutec in France (INRS NS286).

Learn more about us on our homepage, [www.systemedstrom.com](http://www.systemedstrom.com).



### Vice

Depth	Width	Height	Kg	Part.No
360	135	140	10,3	5004

The forged vice is complete with pipe jaw and turning plate. Max opening 140 mm.



### Vice Holders

Depth	Width	Height	Kg	Part.No
1110	210	195	9,4	5012
1110	210	80	8,9	5013

Plate measurement 180x210 mm. Cover 2950 is included.



### Gas bottle holder adjustable

Depth	Width	Height	Tube Ø	Kg	Part.No
150	300	97	< 300	0,9	2910

Liquefied petroleum gas P6 (bottles with 320 mm Ø can be stored after modification).

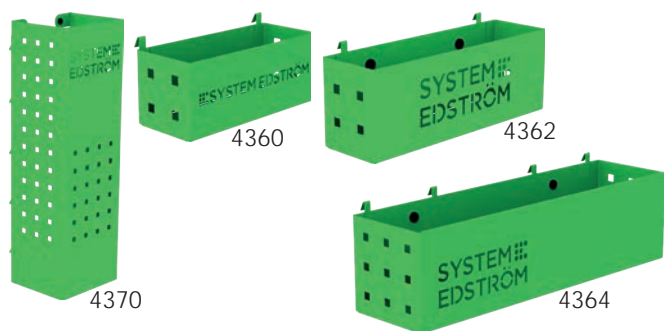

### Pegboard tray

Depth	Width	Height	Kg	Part.No
82	200	80	0,5	4360
82	285	102	0,8	4362
122	455	122	1,5	4364
153	179	575	3,0	4370

A number of different trays that solve (almost) all storage problems.



### Internal ladder holder

Length	Kg	Part.No
2400	5,5	T8900

Store your ladder on the inside of the roof, pull it back to the rear door in a simple operation. The aluminum rail comes in two parts with a joining piece.





### Hose/Cable rack

Depth	Width	Height	Kg	Part.No
79	267	168	0,5	4077

### Tube holder

66	194	123	0,4	4349
----	-----	-----	-----	------

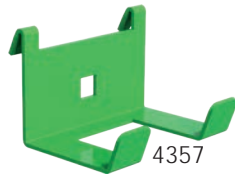

### Universal hook

Depth	Width	Height	Kg	Part.No
85	80	100	0,2	4356
61	83	55	0,1	4357

Simplicity at its best, heavy duty hooks, to be mount on a pegboard or hang it on the edge of a shelf.

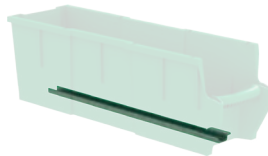
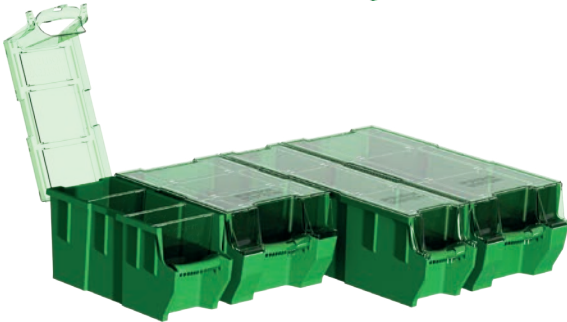

### Plastic bin for shelves

Depth	Width	Height	Kg	Part.No
300	145	154	0,4	3050
300	235	154	0,5	3052
470	145	154	0,5	3055
470	235	154	0,5	3057

### Transparent lid for plastic bins

Depth	Width	Fits	Kg	Part.No
300	150	3050	0,2	3060
300	240	3052	0,2	3062
470	150	3055	0,2	3065
470	240	3057	0,4	3067

### Dividers for plastic bins

Width	Height	Fits	Part.No
140	154	3050, 55	3070
230	154	3052, 57	3072

### Bracket for dropfront shelves

Depth	Kg	Part.No
300	0,1	3081
470	0,2	3082



### Clothes hook

Depth	Width	Height	Kg	Part.No
31	295	40	0,3	2706
31	465	40	0,5	2708

We call it a clothes hook but, needless to say, you can use it to hang up whatever you want on it.



### Strap with brackets

Information	Width	Part.No
1200 mm, nylon strap	25	4365
1000 mm, elastic strap	25	4366

The brackets will fit on our pegboards.

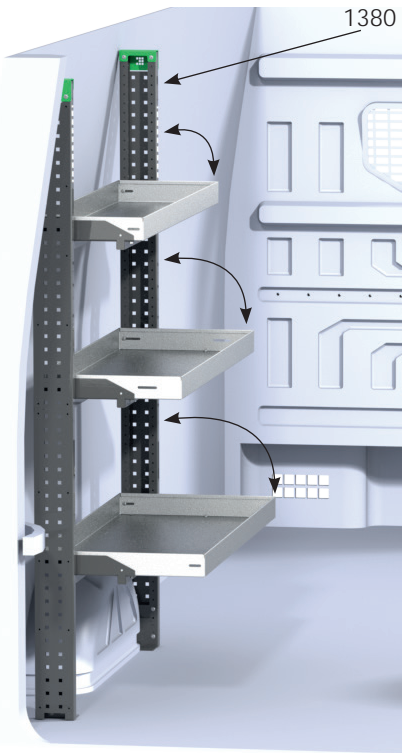

### Flexi shelf frame

Depth	Width	Height	Info.	Kg	Part.No
112	32	1788	2/set	11,8	1380
112	31	1788	1/set	4,9	1382

### Flexi shelf support

Depth	Width	Height	Shelf width	Kg	Part.No
275	830	83	784	3,1	1308
275	1043	83	997	3,5	1312
275	1222	83	1176	3,9	1316
275	1435	83	1389	4,4	1322
275	1614	83	1568	4,8	1326

### Flexi shelf bracket

Info.	Kg	Part.No
160 mm deep shelves, 2/set	0,6	1340
300, 400 & 470 mm deep shelves, 2/set	1,4	1342

### Flexi gas damper

Info.	Kg	Part.No
2/set	0,1	1386

The shelf frames can be cut to fit your configuration. Loading capacity increases to 100 kg per shelf when mounted in a Flexirack. Shelves are adjustable to 4 pre-set angle on installation of 0, 4, 8 & 12 degrees.

Choose your shelves , 300, 400 and/or 470 mm depth. Our dropfront shelves will also fit, 300 and 470 mm depth. A shelf bracket will fit all different shelf depths.

Use the shelf bracket if you want to combine 160 mm deep shelves with other depths. 160 mm shelves are fixed, not foldable.

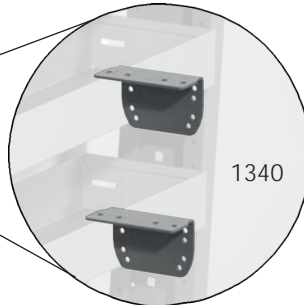

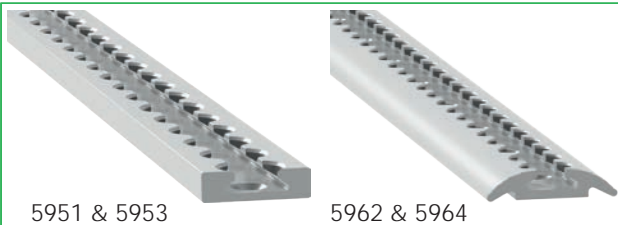

5951 & 5953

5962 & 5964

### Airline tracks

Length	Kg	Part.No
295	0,2	5951
465	0,3	5953
1000	0,8	5962
1500	1,2	5964



2813

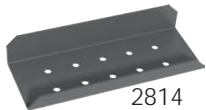

2814



5904



5905



5900

5901

### Airline lashing rings

Information	Kg	Part.No
Round aluminium	0,1	5900
Straight black plastic	0,1	5901



5910



5911

### Airline brackets

Information	Kg	Part.No
Angle bracket 53x80x112 mm	0,2	2813
Support plinth bracket 175x66x15/32 mm	0,3	2814
Bracket for shelf frame	-	5904
Bracket for plywood	-	5905
T-nut 2xM6	-	5910
T-nut 3xM6	-	5911
Mounting bolt M8x25	-	5913
Clamp fitting	0,3	5915



5913



5915



5931 - 5935



5940

### Airline straps

Information	Length	Kg	Part.No
Strap	200/ 700	0,1	5931
Strap	200/1200	0,1	5933
Strap	200/2200	0,2	5935
Strap with tensioner	500/2500	0,3	5940
Adjustable beam	1100-1550	2,6	5993
Adjustable beam	1500-2200	3,5	5996

5993 & 5996

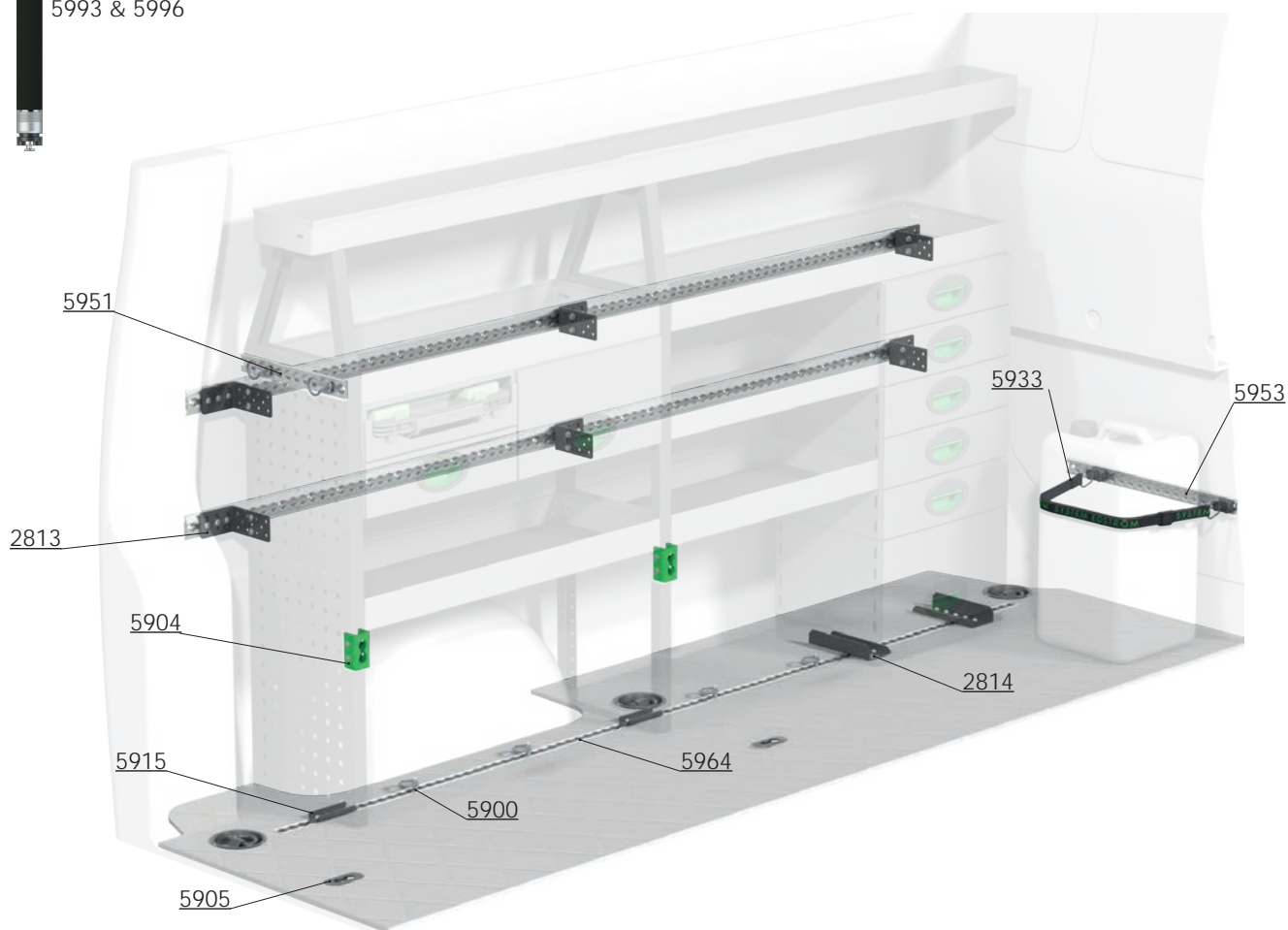

# ACCESSORIES

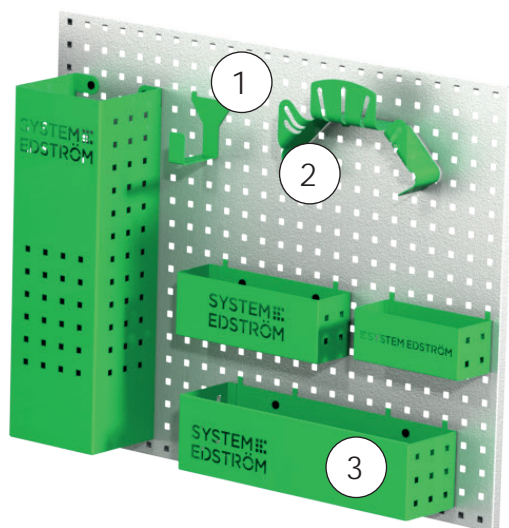
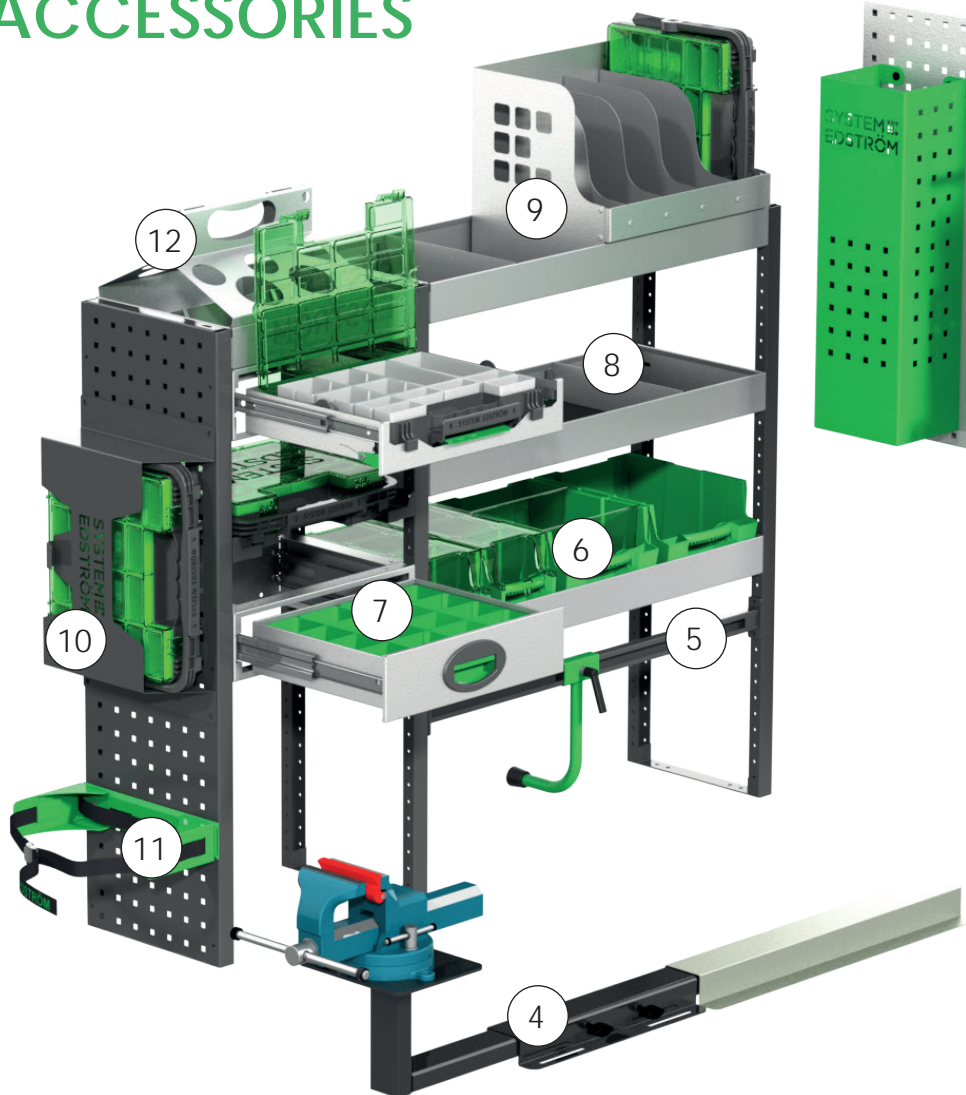

Pos.	Description
1	Universal hook
2	Cable/Hose rack
3	Pegboard basket
4	Vice and holders
5	Case support
6	Plastic bins
7	Drawer inserts
8	Shelf dividers
9	Tool case/File holder
10	Tool case
11	Gas bottle holders
12	Can/Tube holder

## Accessory package No. 1

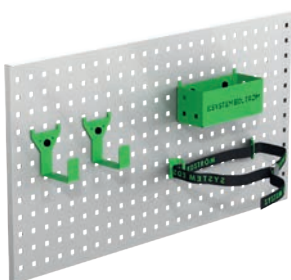

Art.No  
F11001

*Pegboard not included.*

## Accessory package No. 2

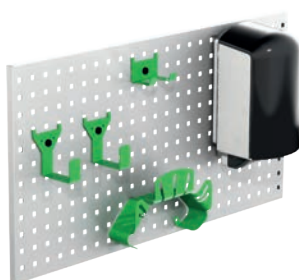

Art.No  
F11002

*Pegboard not included.*

## Accessory package No. 3

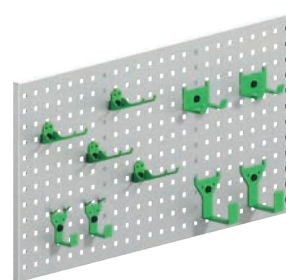

Art.No  
F11004

*Pegboard not included.*



Up to 5 years  
warranty



Crash tested

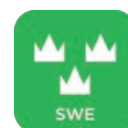

Made in Sweden

[www.systemedstrom.com](http://www.systemedstrom.com)

**SYSTEM  
EDSTRÖM**

SYSTEM EDSTRÖM BILINREDNINGAR AB  
Raseborgsgatan 11  
164 74 Kista  
Sweden

CONTACT  
Order +46 (0)10 102 95 00  
Sales +46 (0)10 102 95 01  
Switchboard +46 (0)8 590 920 20  
[info@edstrom.se](mailto:info@edstrom.se)